



Mortise Deadlock

SM Series



Applications

- SM series Mortise Deadlocks are the ideal for use in the restrooms and small doors in the public utilities, such as the electric meter cabinets or gas meter cabinets in the commercial buildings.
- The locks offer more high security when used as auxiliary deadbolt in other applications.

Specifications

- Installation for 1-3/8" (35mm) or 1-3/4" (44.5mm) doors.
- Backset: 2-3/4" (70mm)
- Deadbolt: 1"(25mm) throw
- Finishes: US3,4,9,10,10B,15,26,26D,32,32D

Certifications

- UL and cUL listed to Canadian safety standard for A label (3-hour fire door)
- Stamped letter F and UL symbol on armor faceplate
- Positive Pressure Meet positive pressure requirements UL 10C and UBC 7-2 (1997)

Models

SM140 Cylinder & Thumbturn

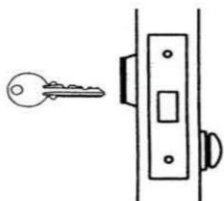

Outside Inside
Deadbolt thrown or retracted by key outside or thumbturn inside.

SM142 Single Cylinder

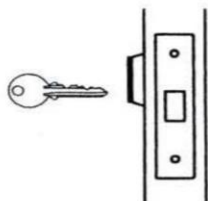

Outside Inside
Deadbolt thrown or retracted by key from outside. No trim on opposite side.

SM143 Double Cylinder

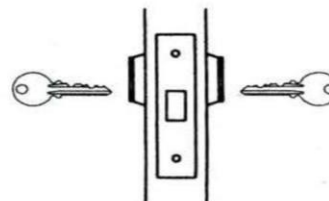

Outside Inside
Deadbolt operated by key from either side.

SM141 Classroom Lock

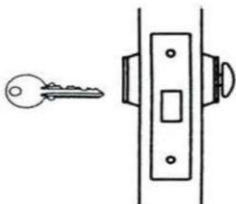

Outside Inside
Deadbolt thrown or retracted by key from outside. Inside thumbturn cylinder retracts deadbolt but cannot project it.

SM145 Door Bolt

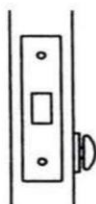

Outside Inside
Deadbolt thrown or retracted by thumbturn inside. No trim on opposite side.

SM146 Deadbolt with "OCCUPIED" Indicator

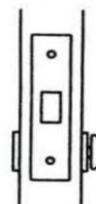

Outside Inside
Deadbolt thrown or retracted by thumbturn inside. When deadbolt is thrown, "OCCUPIED" plate is displayed on outside.

(Original UL listed model numbers are QML180, 182, 184 and 186)



Dimensions

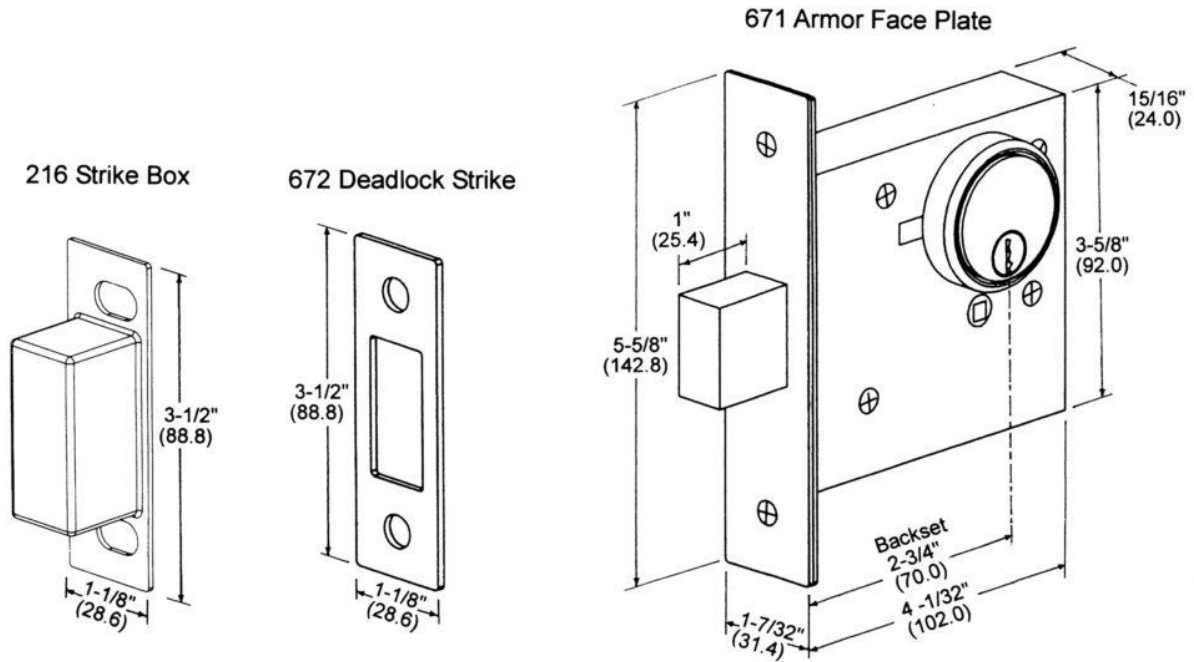

Dimensions in () are millimeters.